



COMUNI DI

**FIUMALBO
PIEVEPELAGO
RIOLUNATO**

(PROVINCIA DI MODENA)

REGOLAMENTO EDILIZIO

Redatto in forma associata

PARTE SECONDA – ESEMPLIFICAZIONI GRAFICHE

Arch. Filippo Fantoni

Con l'apporto collaborativo
Degli Uffici Tecnici Comunali
di Fiumalbo, Pievepelago, Riolunato

APRILE 2007



Figura 1 - PIANO TERRA O PIANO FUORI TERRA
Art. 2 lettera f.3



Figura 2 – PIANO SEMINTERRATO
Art. 2 lettera f.4

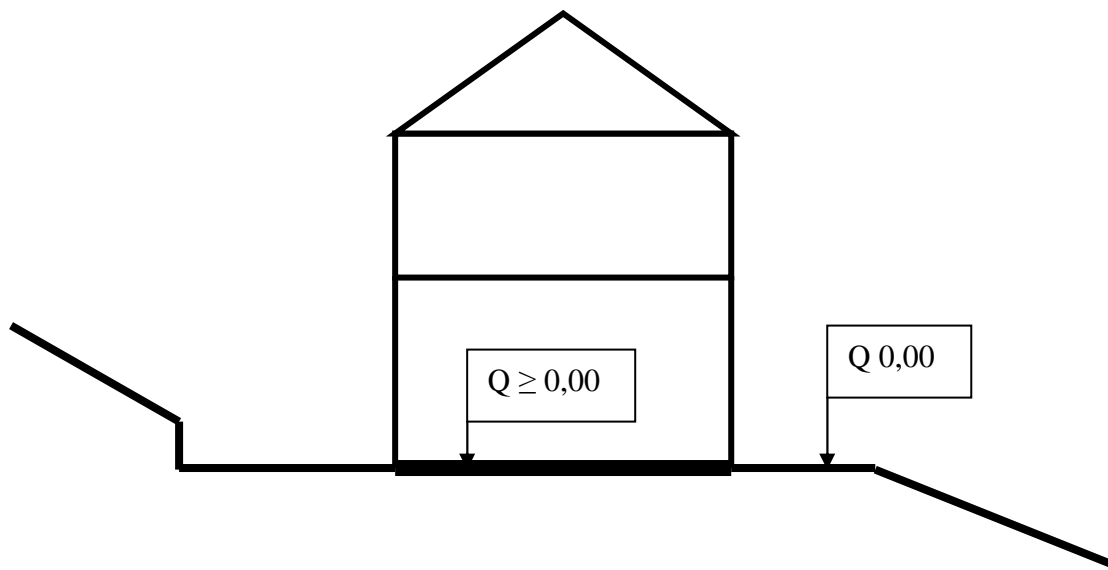

Figura 3 – PIANO INTERRATO
Art. 2 lettera f.5

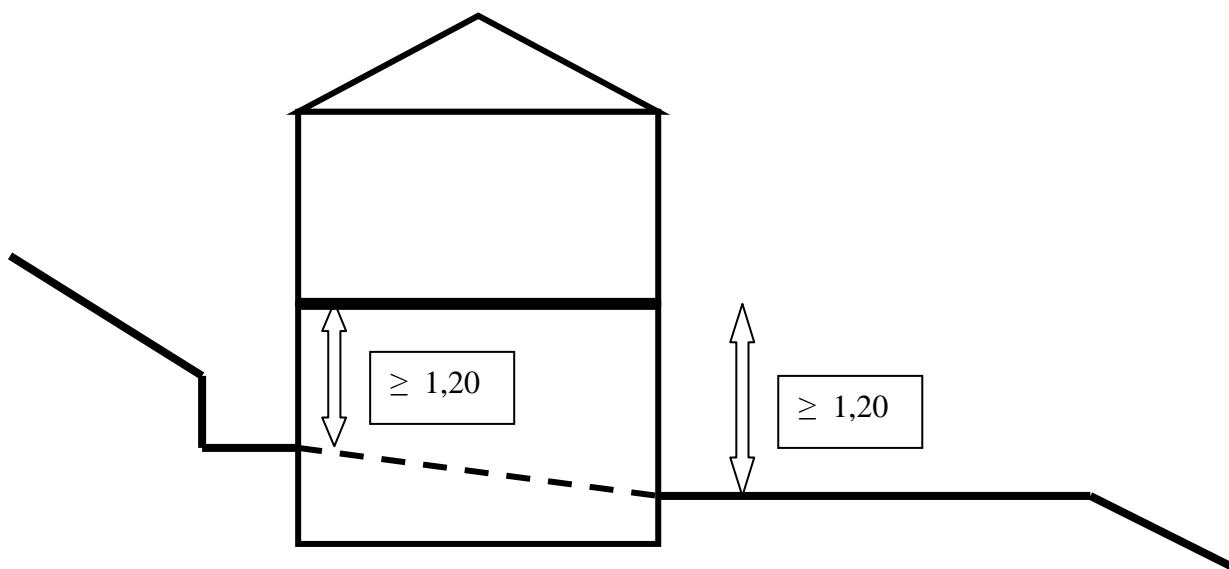

Figura 3 bis – Art. 2 lettere f.4, f.5
L' altezza del tratto A non viene
considerata ai fini della definizione
del piano

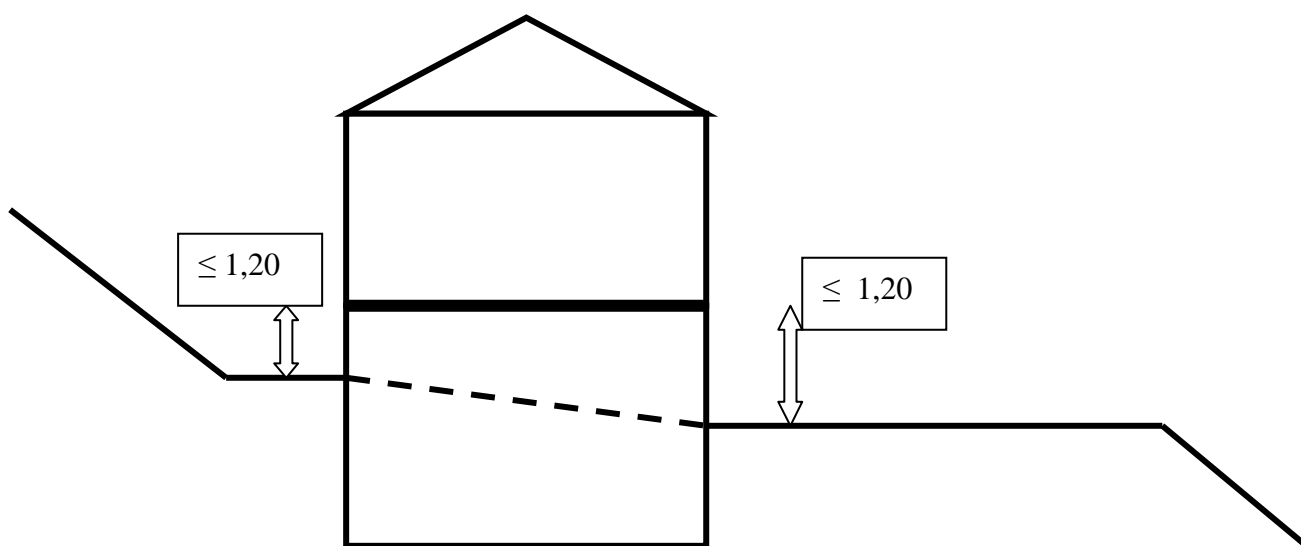

Figura 4 – SOPPALCO – Art. 2 lettera f.6

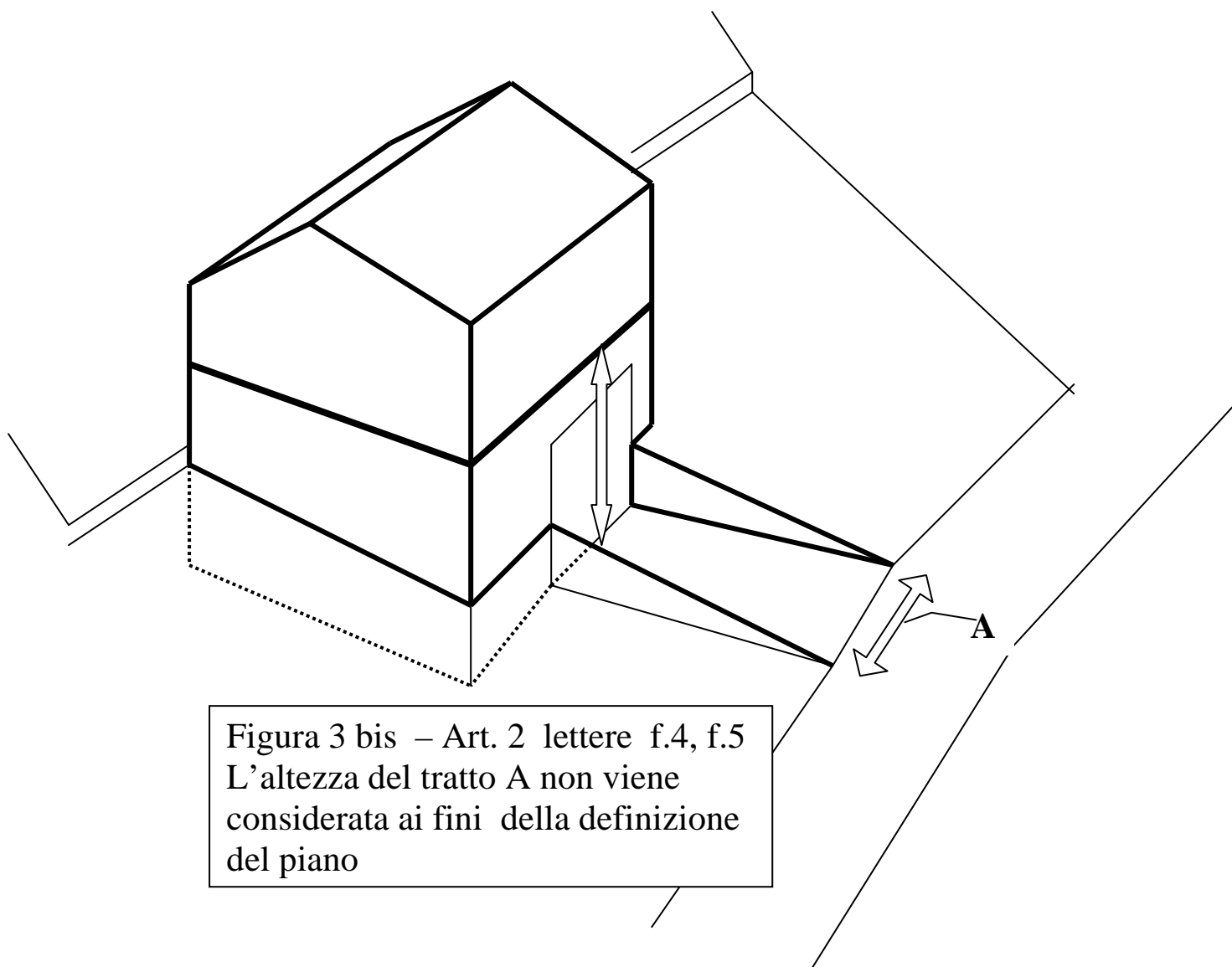

Figura 5 – MODALITA' DI MISURAZIONE DELLE DISTANZE - Art.2 lettera H

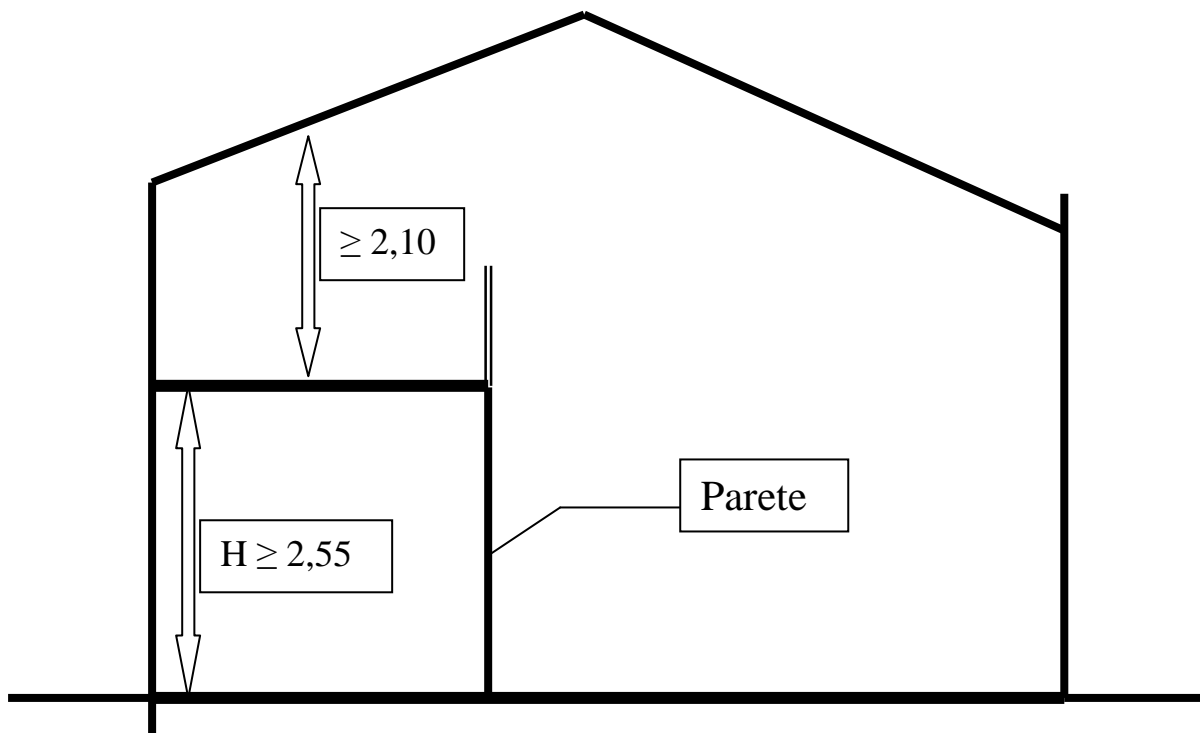
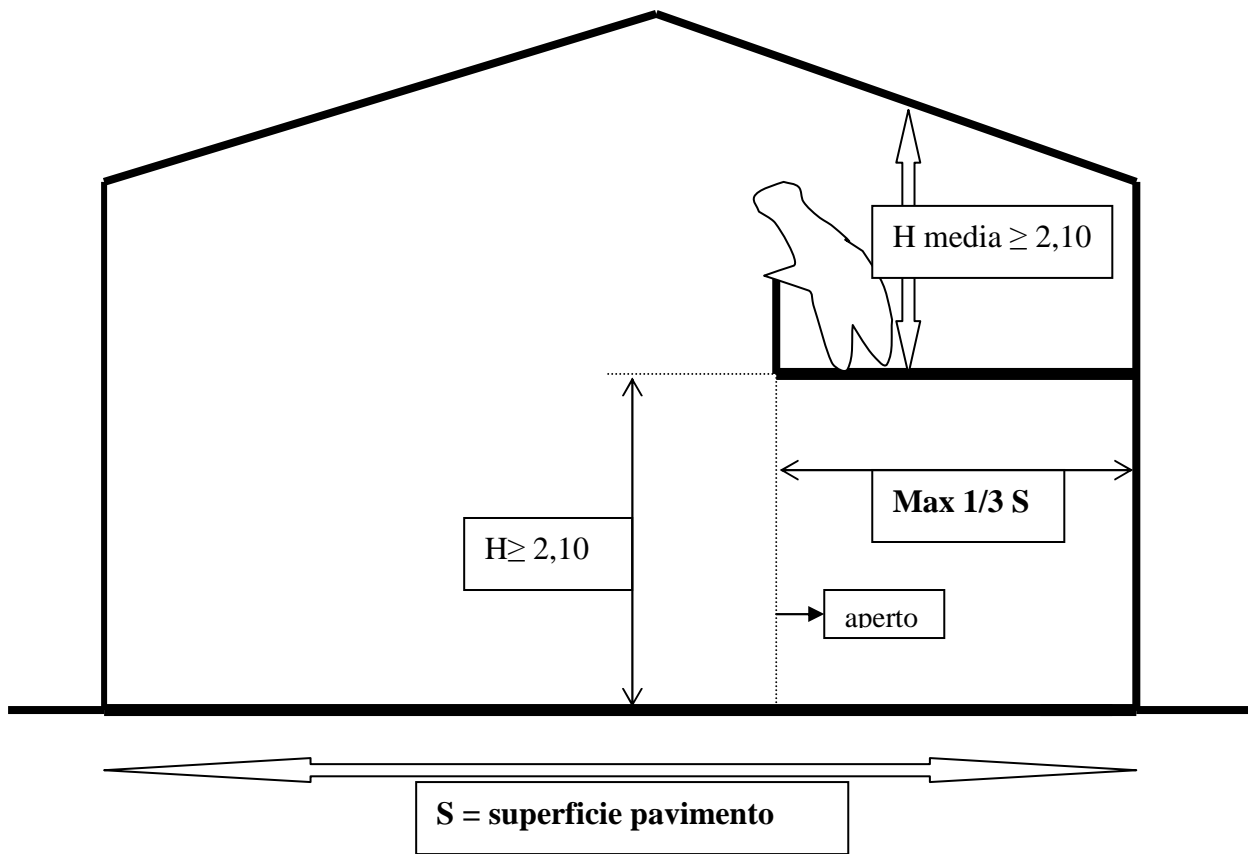

Figura 6 – CALCOLO DELLA DISTANZA PER EDIFICI O PARTI DI EDIFICI EMERGENTI DAL TERRENO Art. 2 lettera O.(A/B)

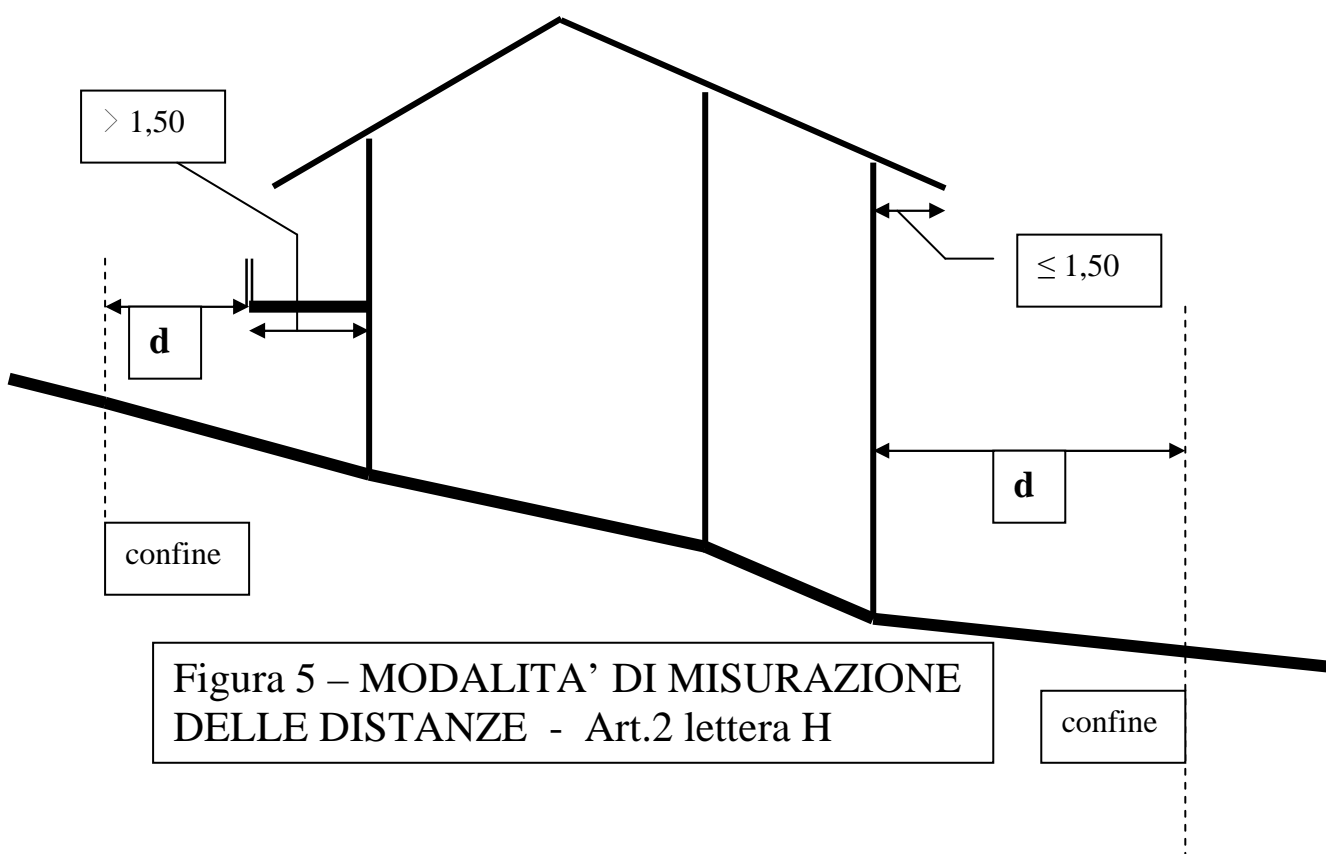
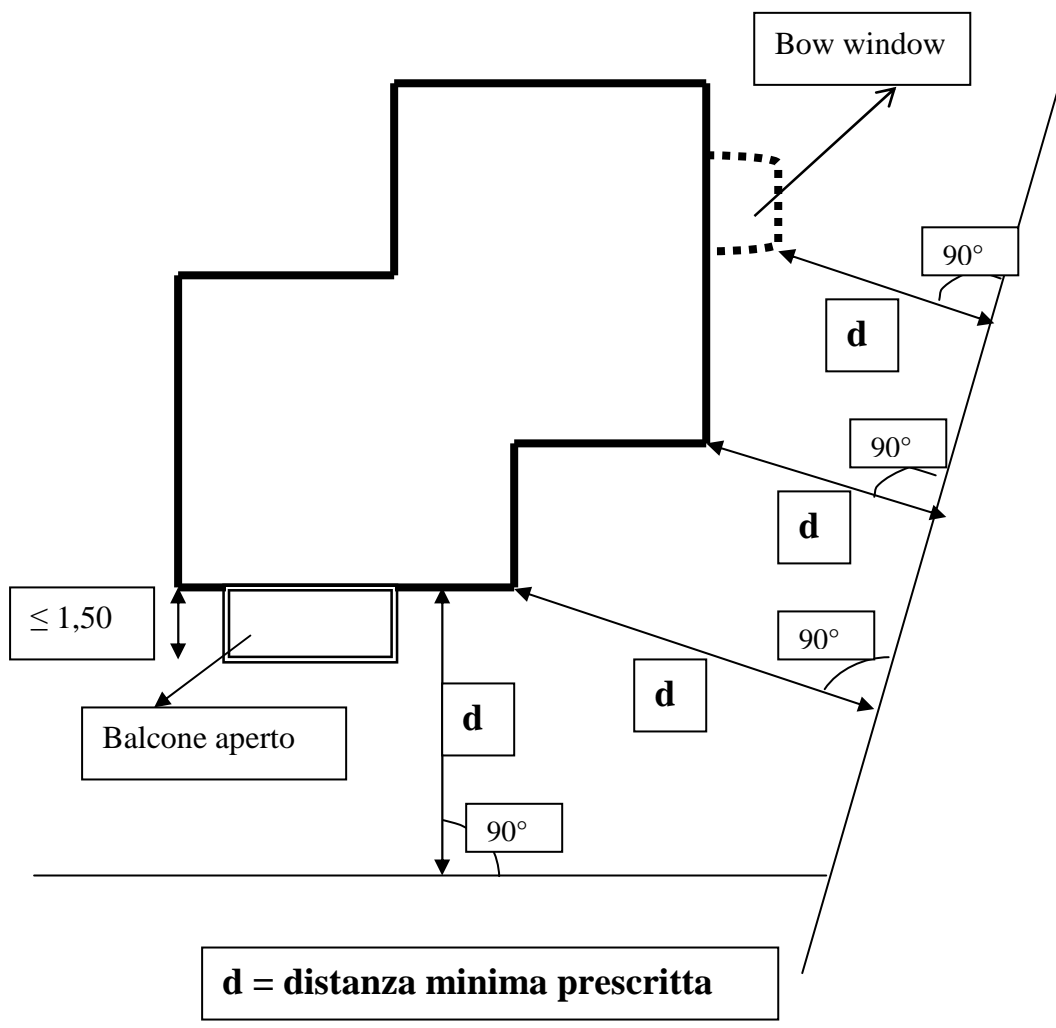

Figura 7 – ESEMPI DI APPLICAZIONE
 DELLA VISUALE LIBERA – Art.2 lettera O/D

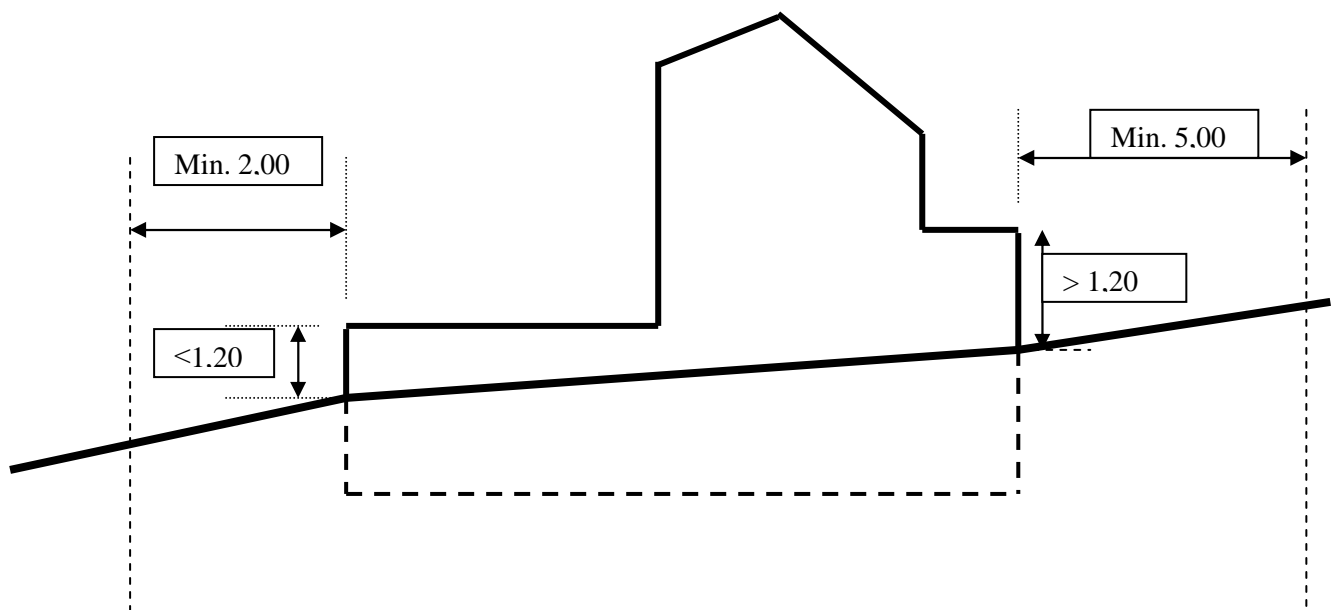

Figura 7 bis – ESEMPI DI APPLICAZIONE
 DELLA VISUALE LIBERA - Art.2 lettera O/D

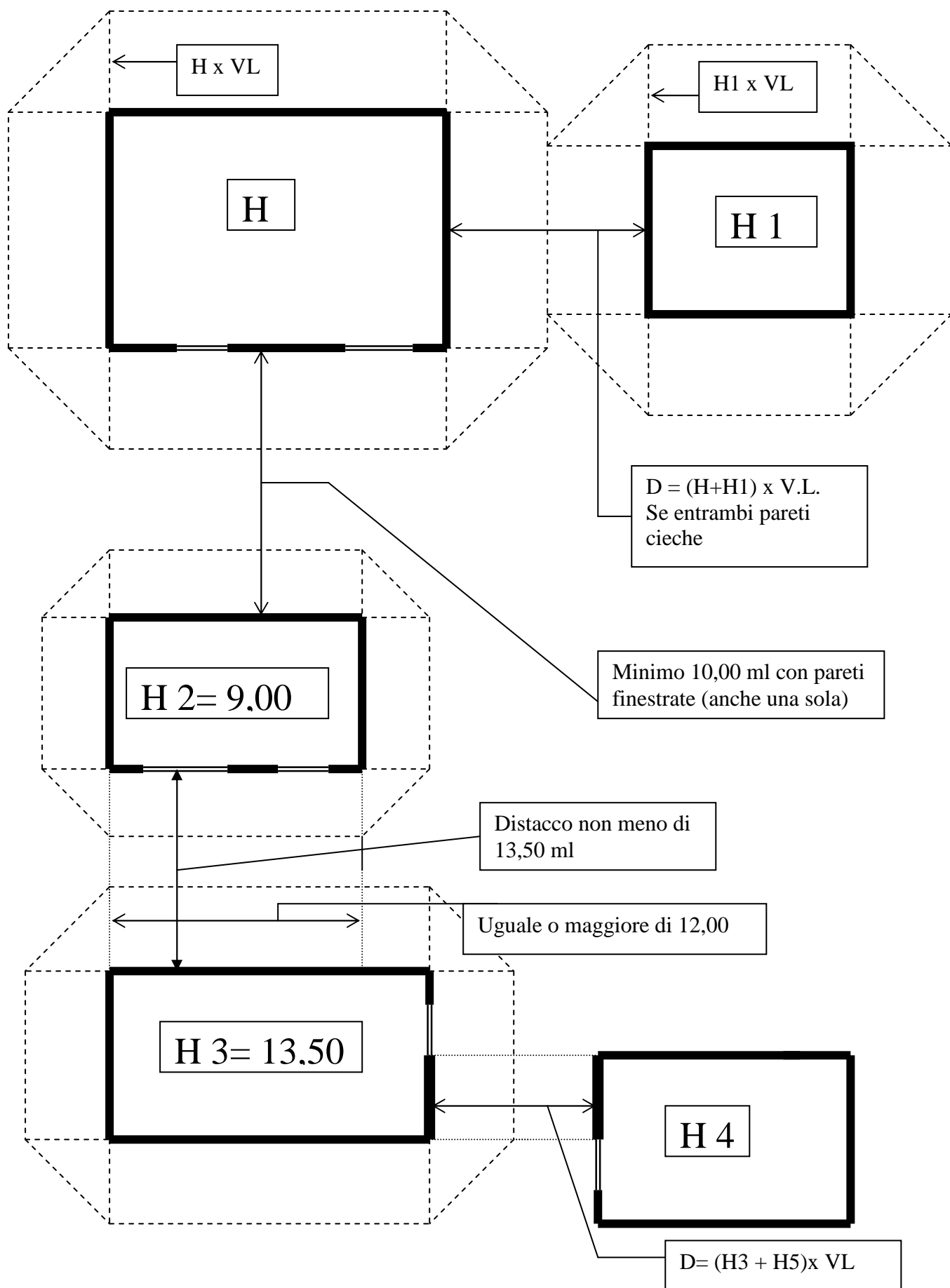

Figura 8 – ALTEZZA DEI LOCALI E DEI PIANI
Art. 2 lettera G



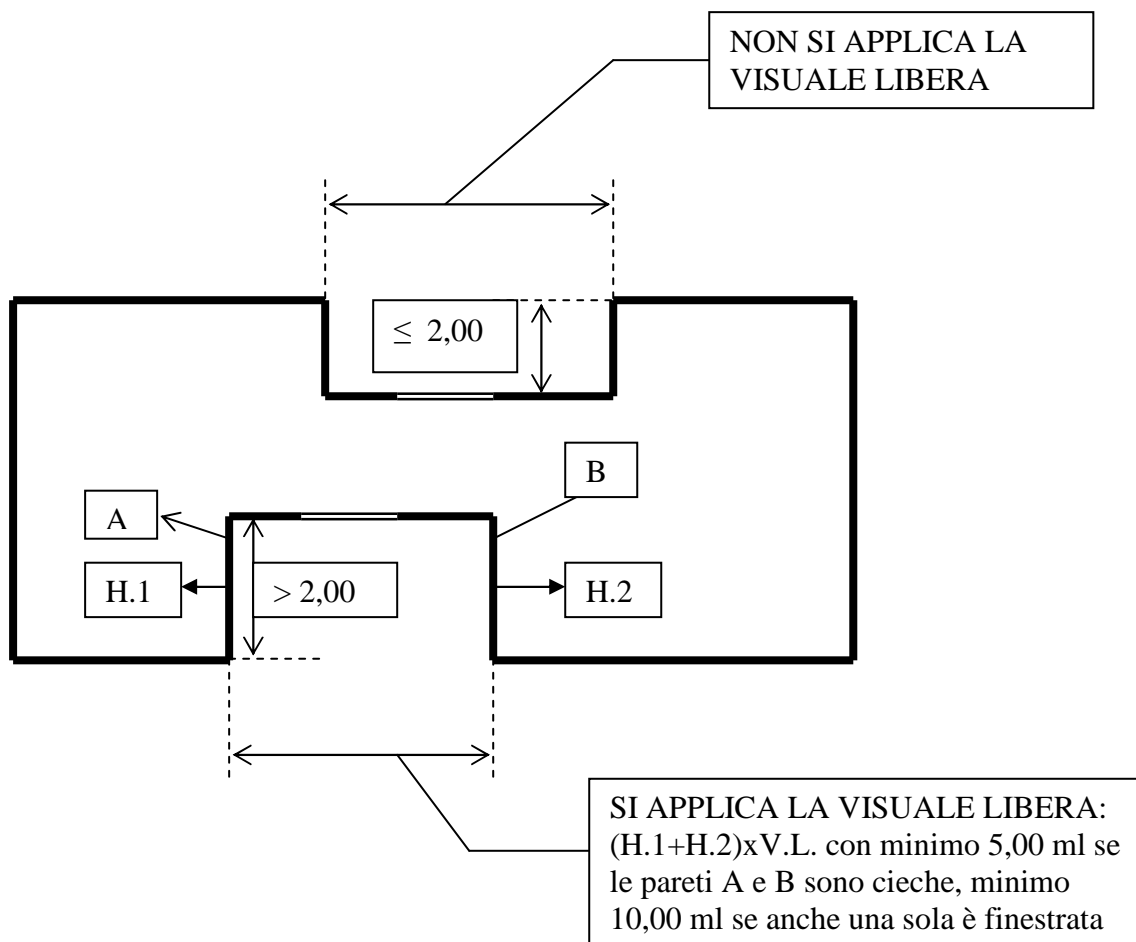

Figura 10 – CALCOLO DELL'ALTEZZA MEDIA PONDERATA DI UN FRONTE: = H_p - Art. 2 lettera G

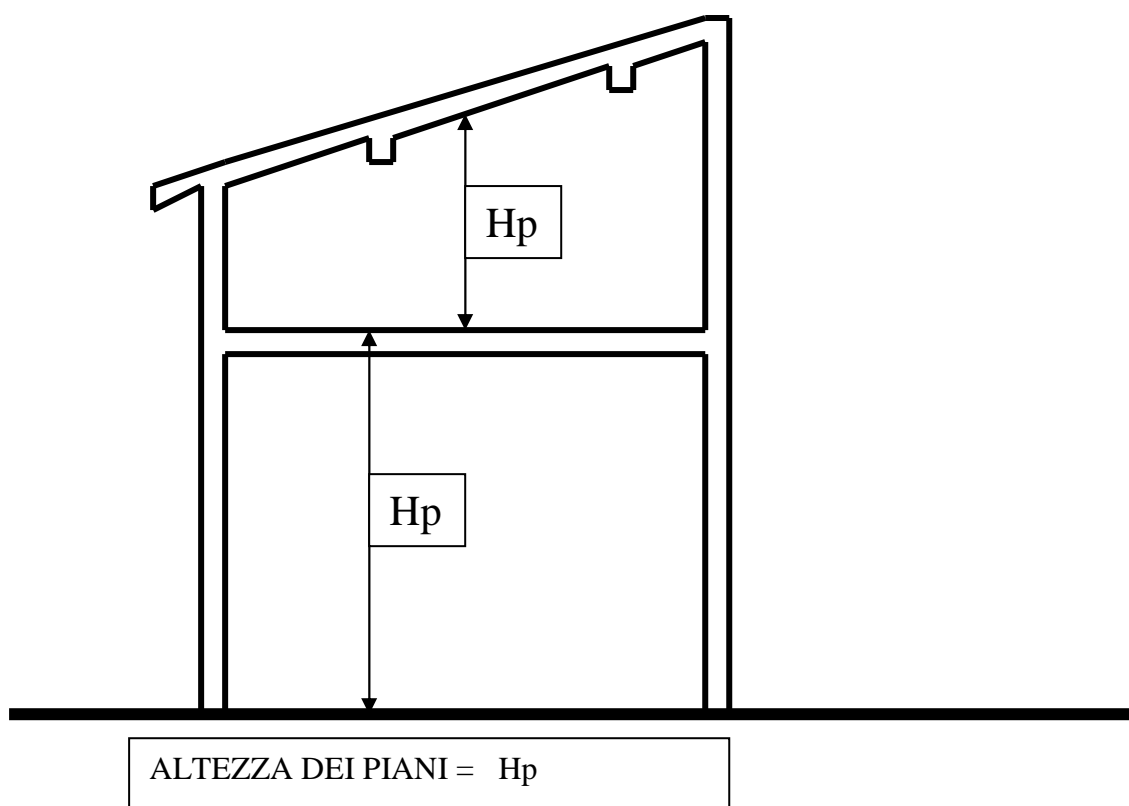
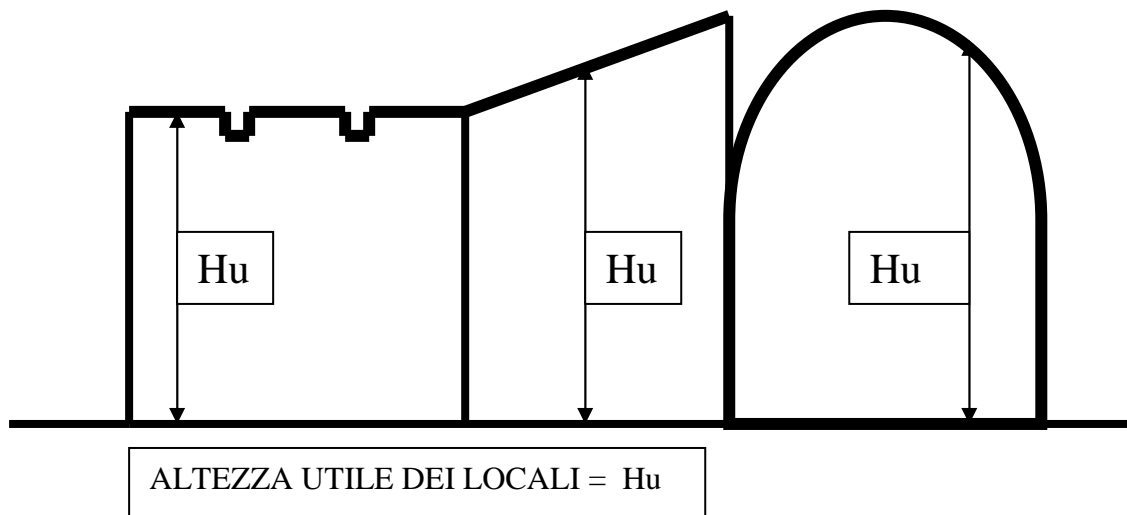
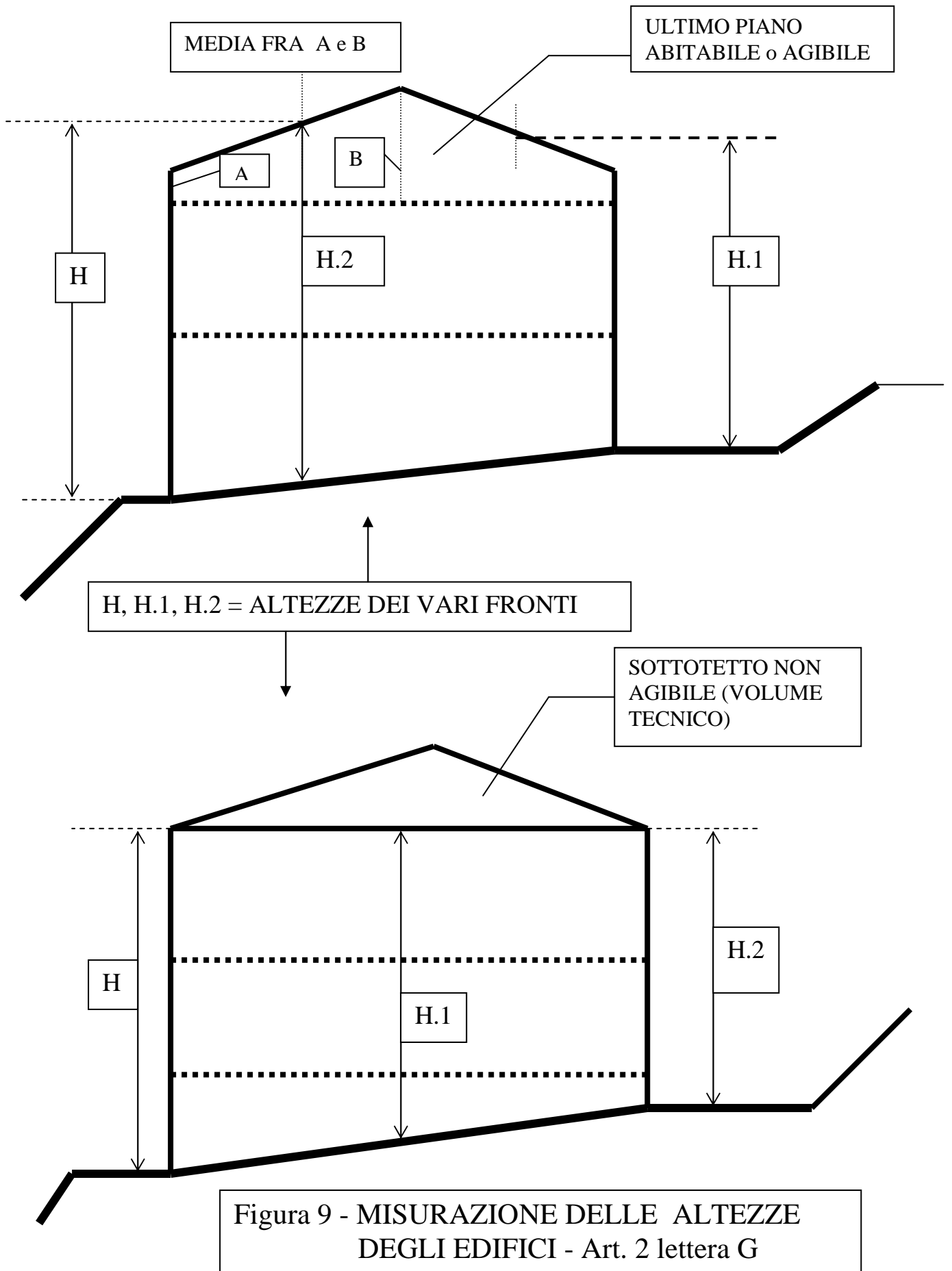
$$H_p = (A + B + C) / d$$

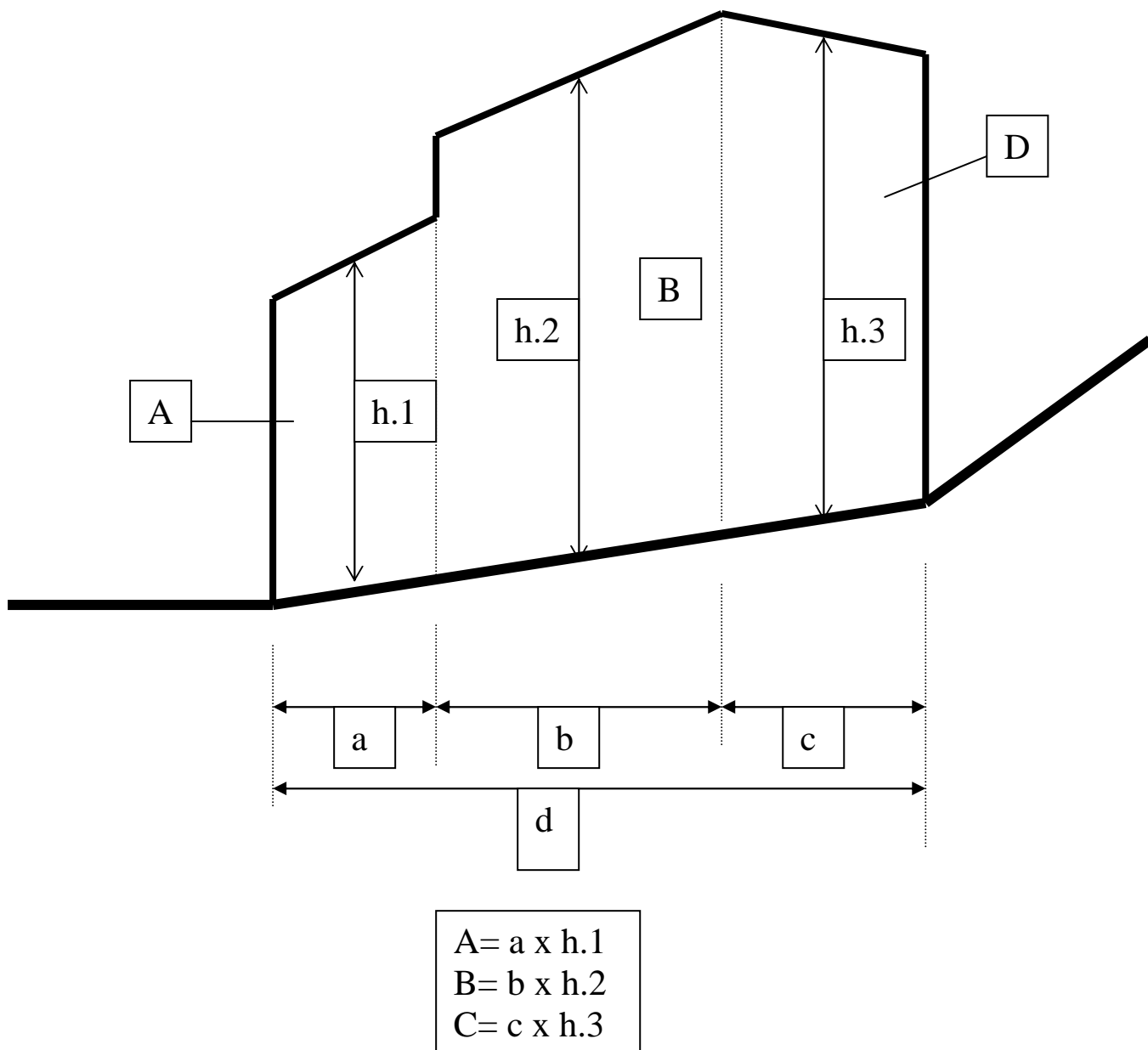
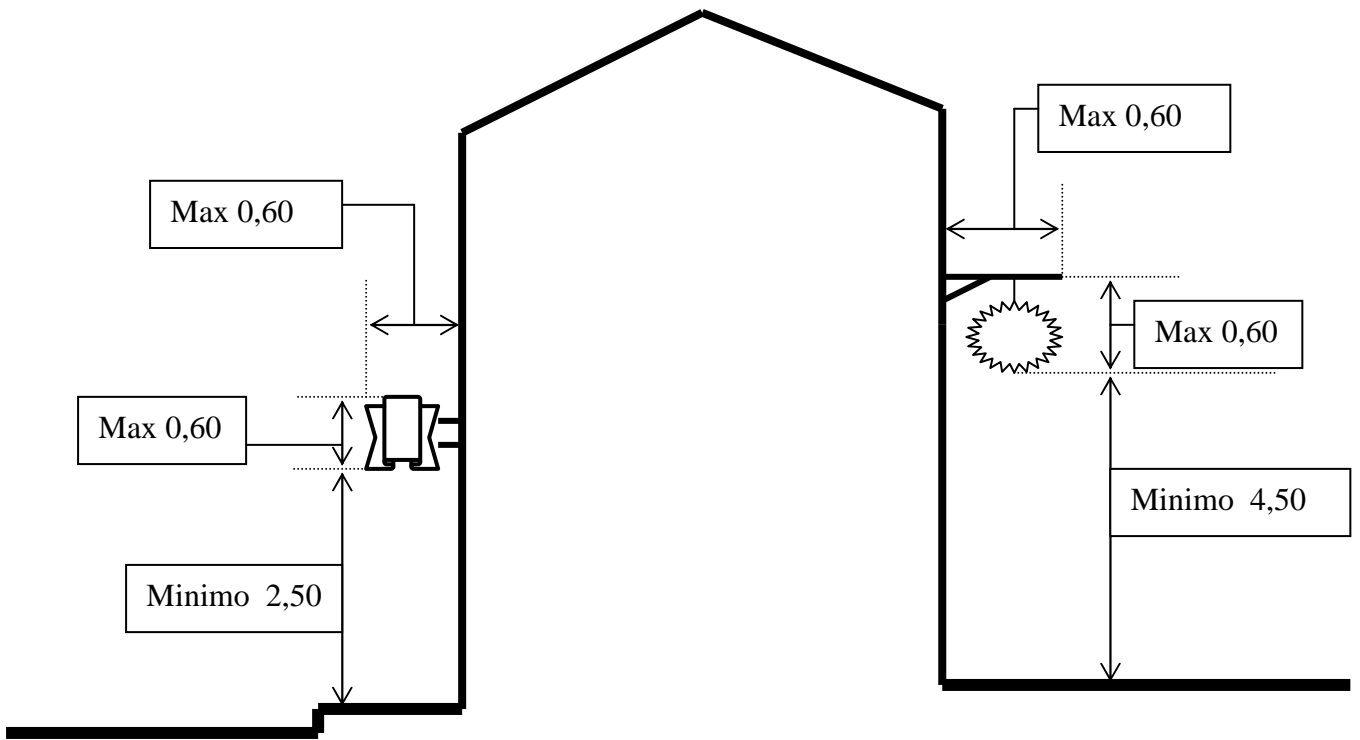

Figura 11 – INSEGNE A BANDIERA – Art. 60 punto 7

Arch. Filippo Fantoni

Con l'apporto collaborativo
Degli Uffici Tecnici Comunali
di Fiumalbo, Pievepelago, Riolunato

APRILE 2007