



**COMUNI DI**

**FIUMALBO  
PIEVEPELAGO  
RIOLUNATO**

(PROVINCIA DI MODENA)

**REGOLAMENTO EDILIZIO**  
**Redatto in forma associata**

**PARTE SECONDA – ESEMPLIFICAZIONI GRAFICHE**

Arch. Filippo Fantoni

Con l'apporto collaborativo  
Degli Uffici Tecnici Comunali  
di Fiumalbo, Pievepelago, Riolunato

APRILE 2007



Figura 1 - PIANO TERRA O PIANO FUORI TERRA  
Art. 2 lettera f.3



Figura 2 – PIANO SEMINTERRATO  
Art. 2 lettera f.4

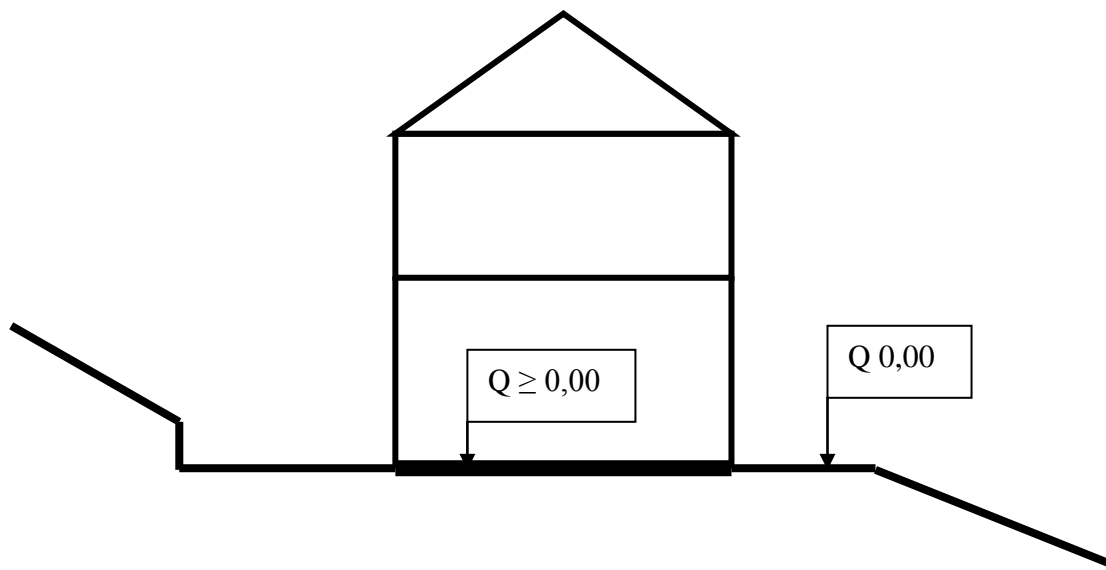

Figura 3 – PIANO INTERRATO  
Art. 2 lettera f.5

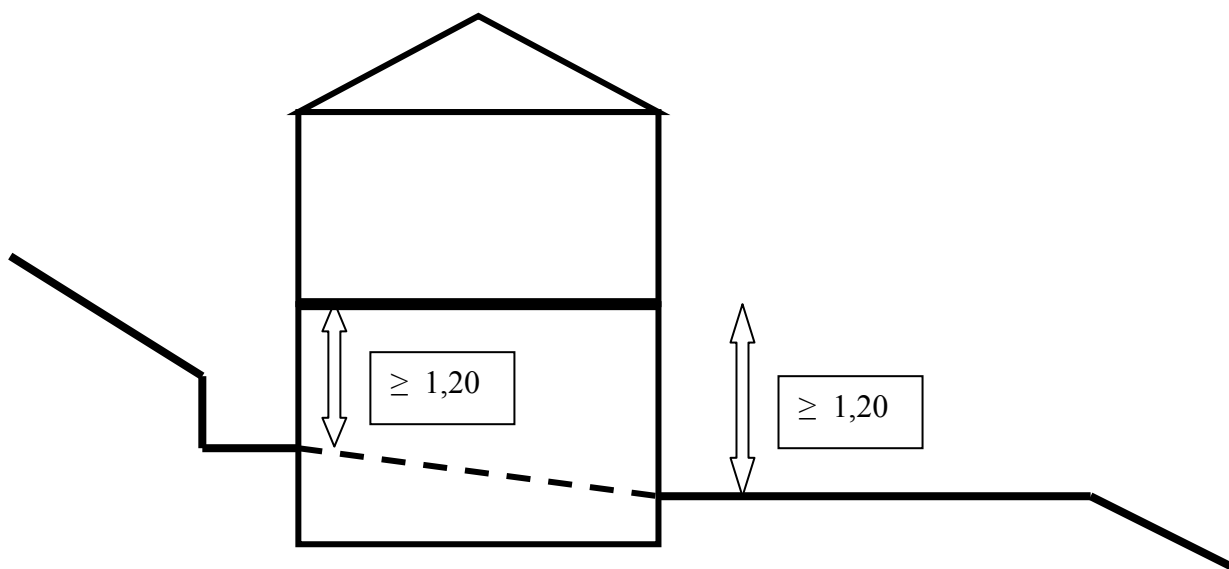

Figura 3 bis – Art. 2 lettere f.4, f.5  
L'altezza del tratto A non viene  
considerata ai fini della definizione  
del piano

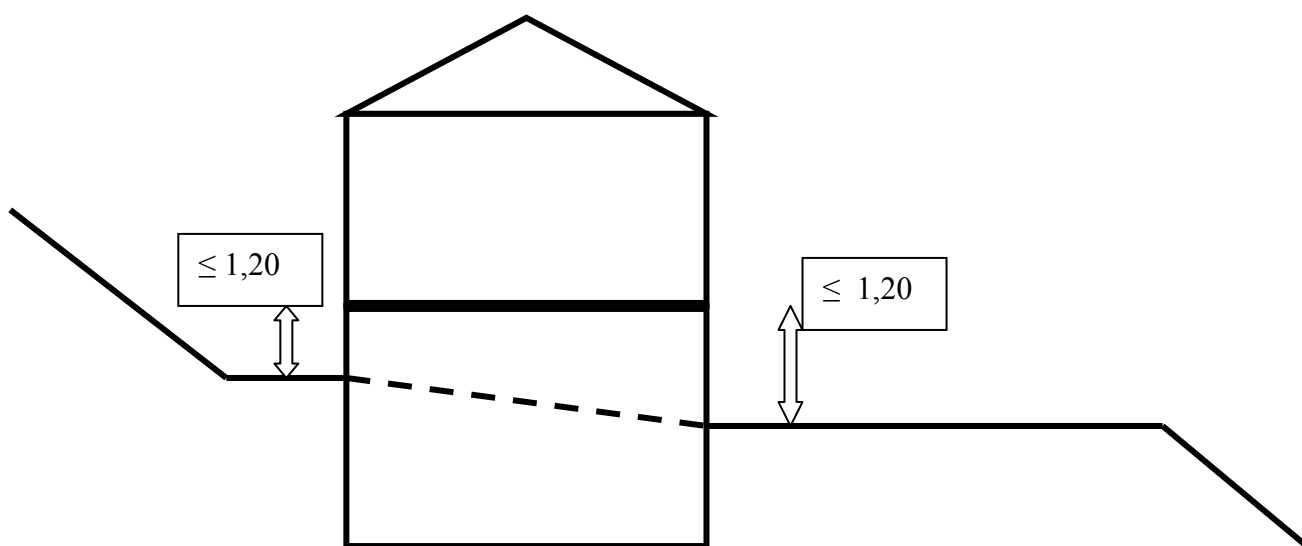

Figura 4 – SOPPALCO – Art. 2 lettera f.6



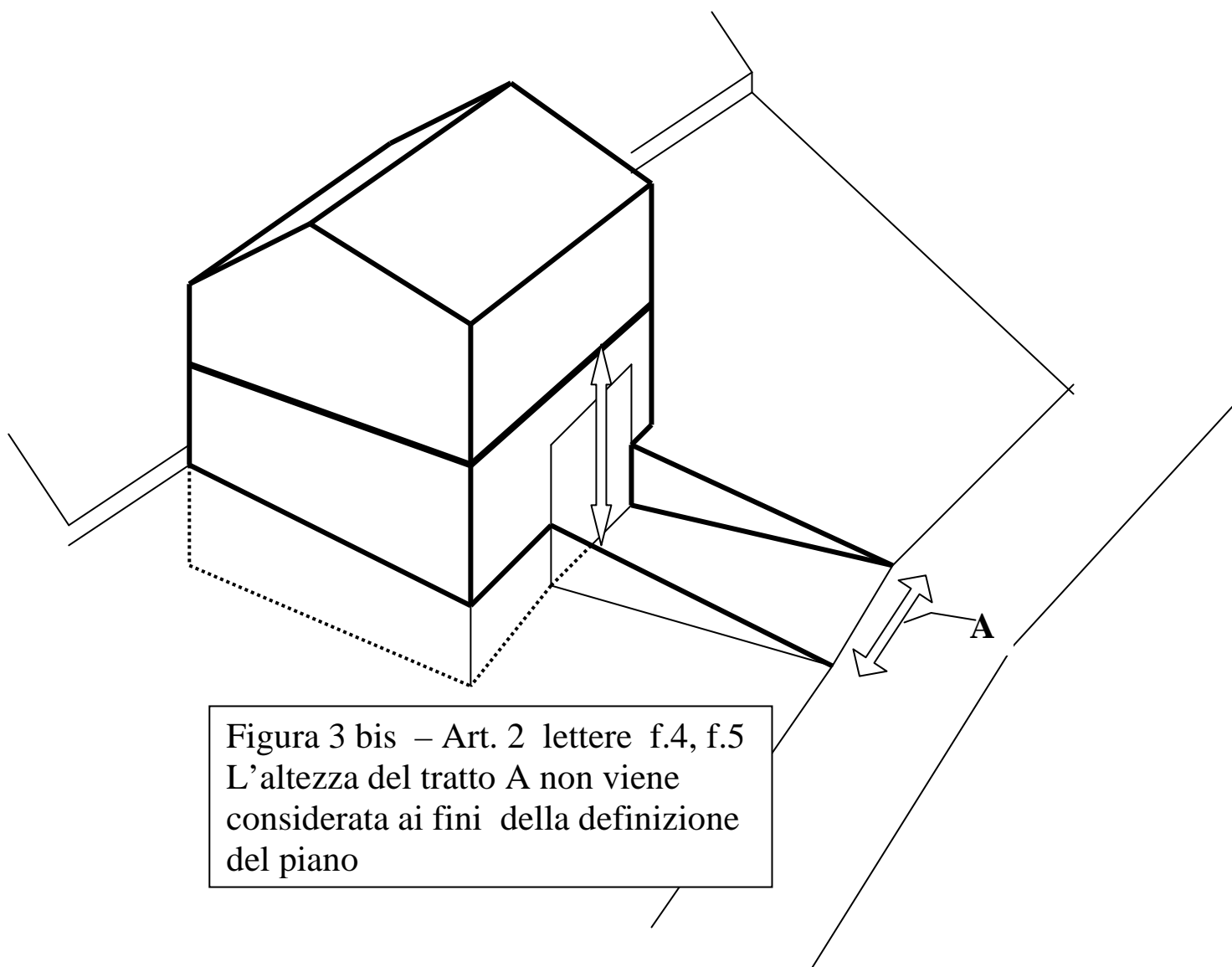

Figura 6 – CALCOLO DELLA DISTANZA PER EDIFICI O PARTI DI EDIFICI EMERGENTI DAL TERRENO Art. 2 lettera O.(A/B)

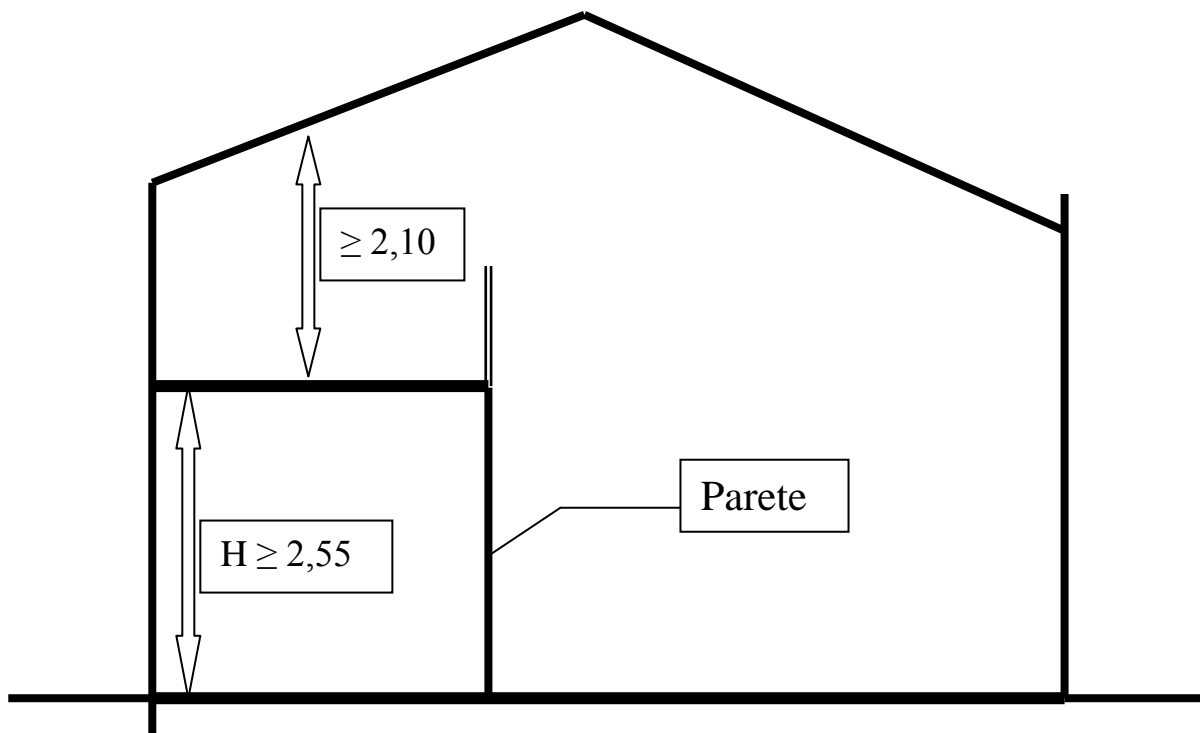
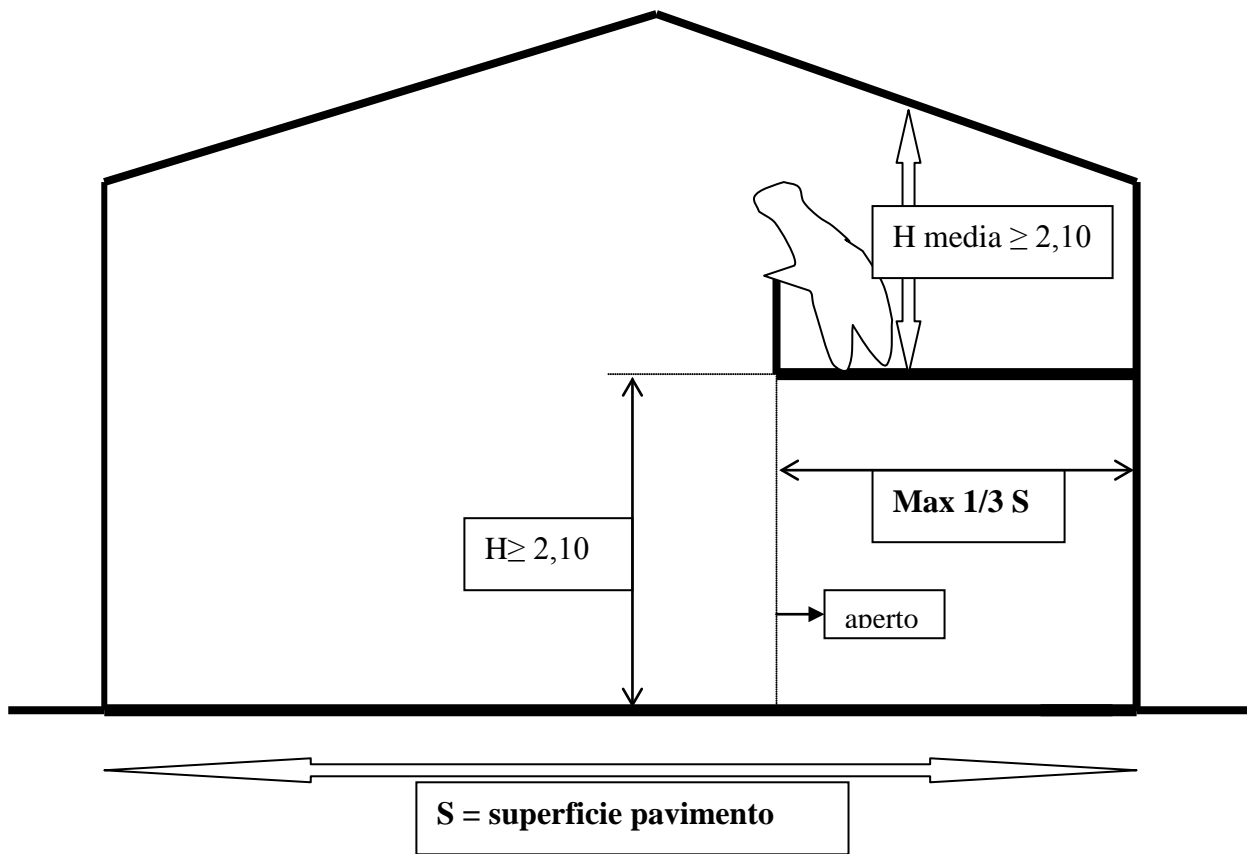
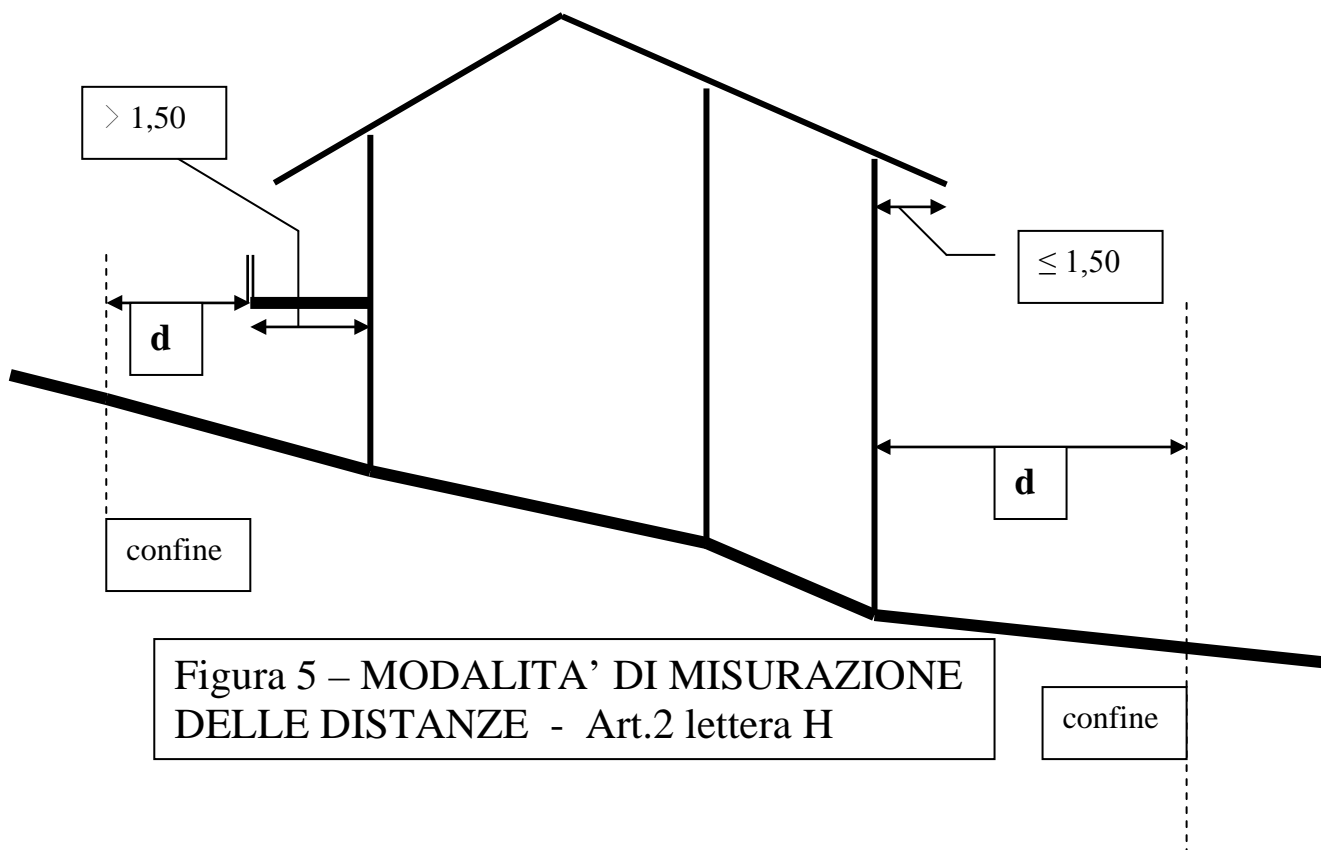
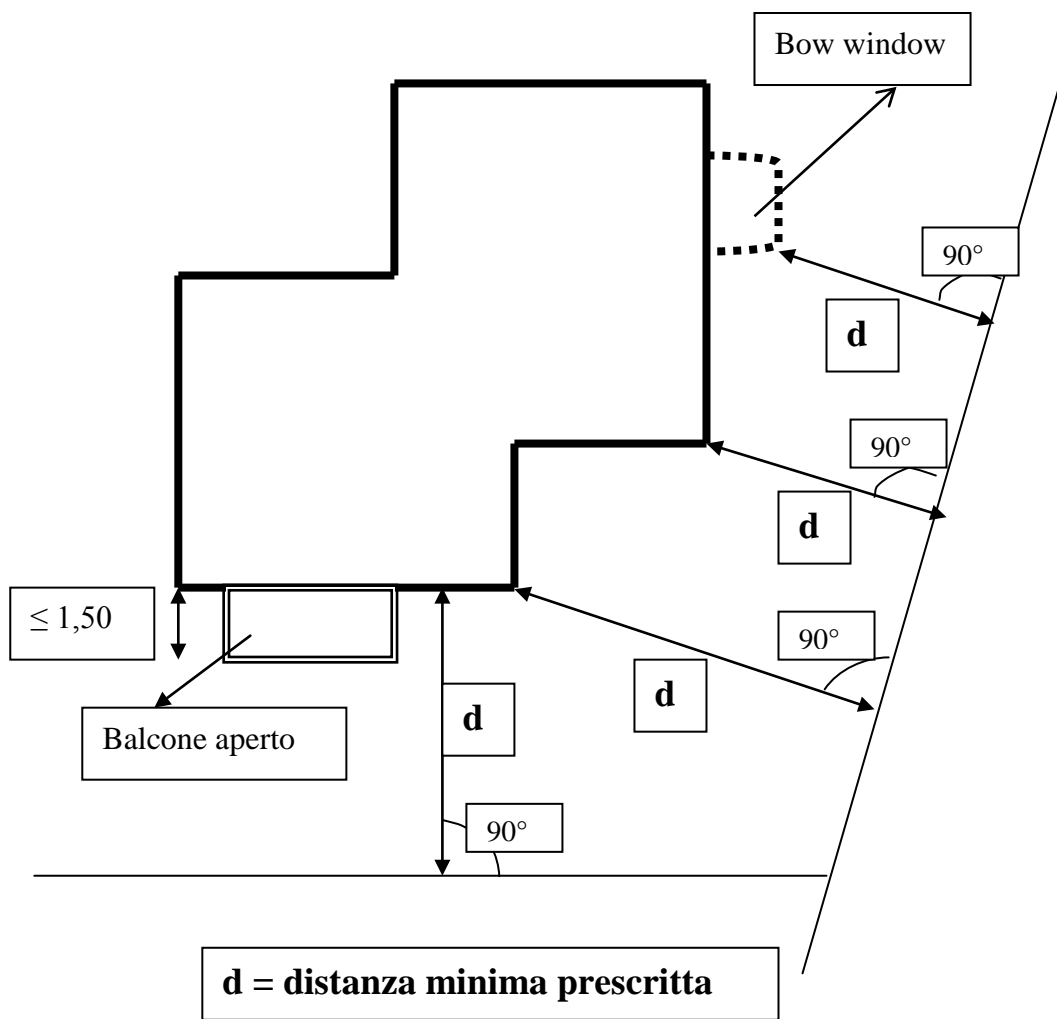

Figura 7 – ESEMPLI DI APPLICAZIONE  
 DELLA VISUALE LIBERA – Art.2 lettera O/D

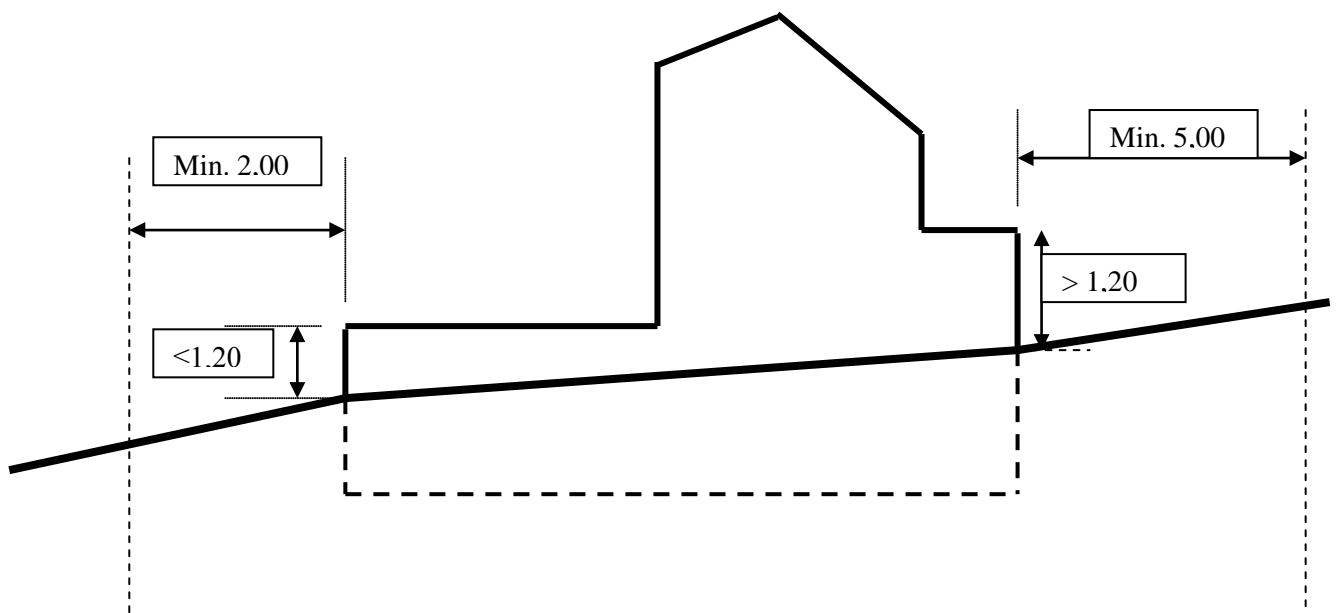

Figura 7 bis – ESEMPI DI APPLICAZIONE  
 DELLA VISUALE LIBERA - Art.2 lettera O/D

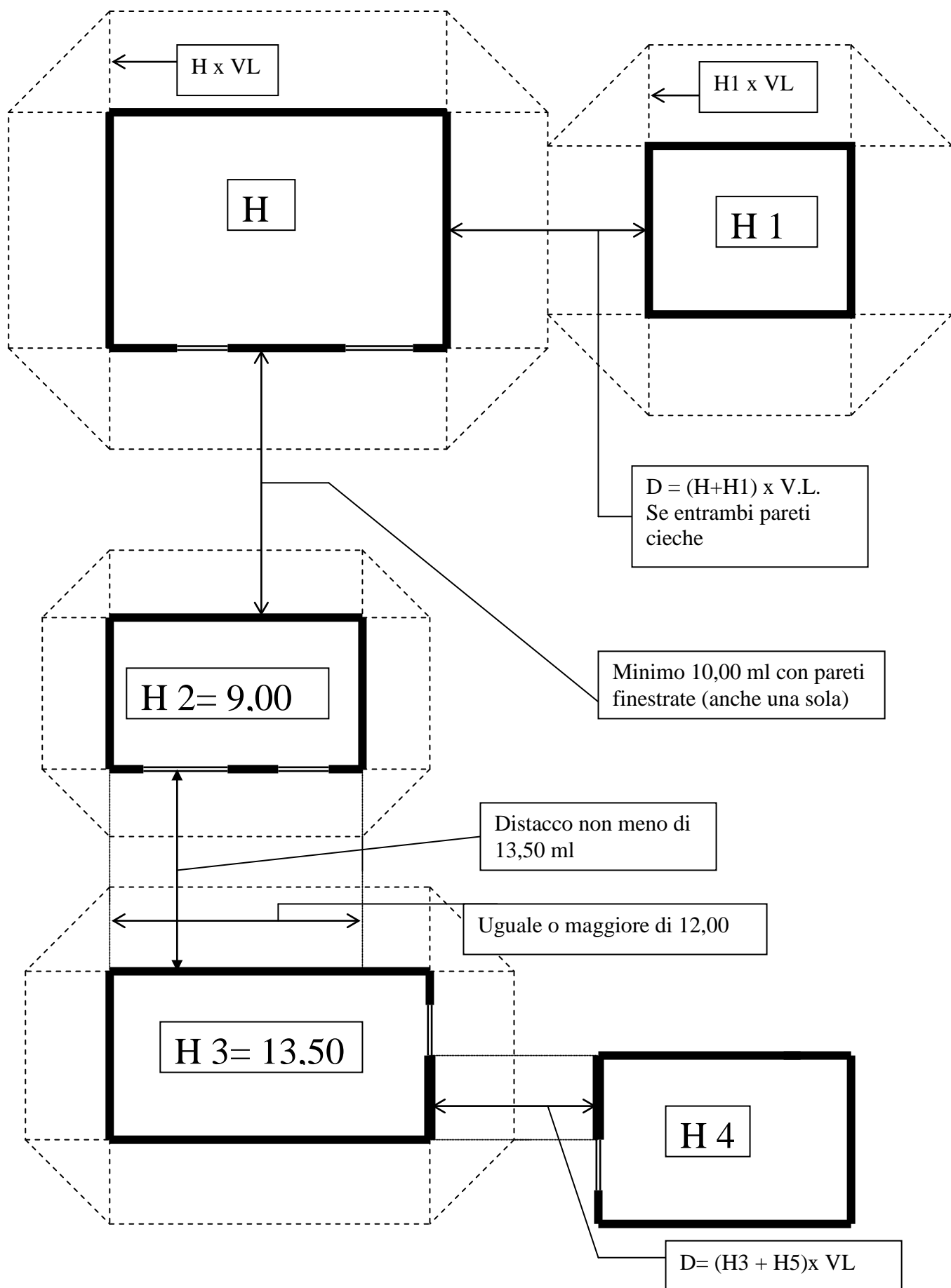

Figura 8 – ALTEZZA DEI LOCALI E DEI PIANI  
Art. 2 lettera G



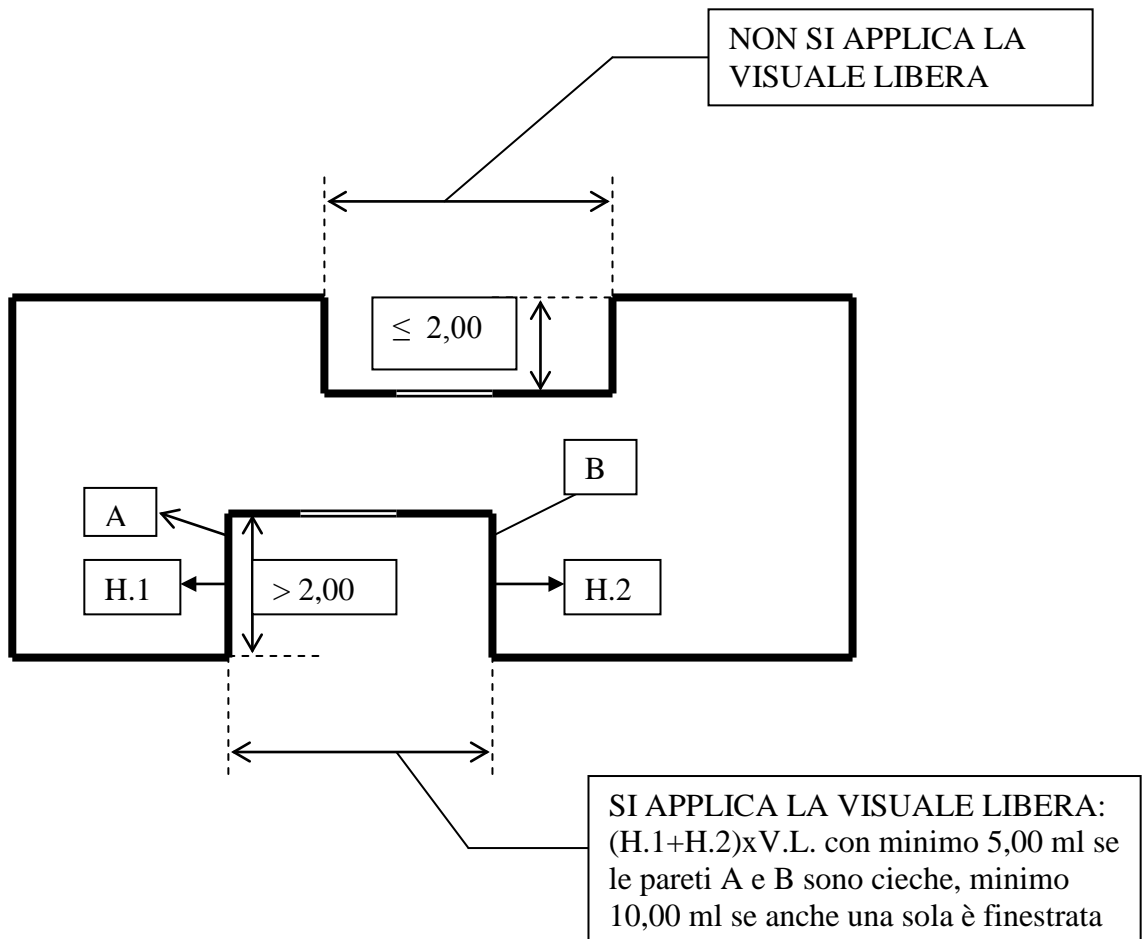

Figura 10 – CALCOLO DELL'ALTEZZA MEDIA PONDERATA DI UN FRONTE: =  $H_p$  - Art. 2 lettera G

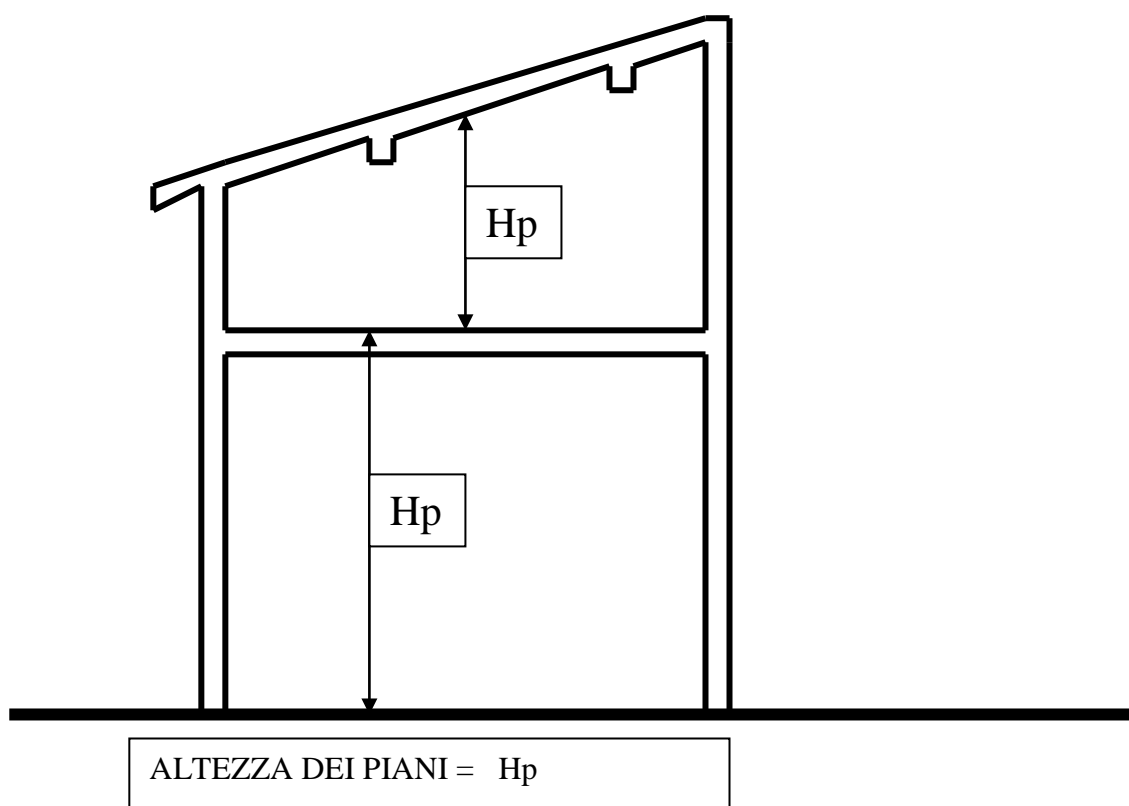
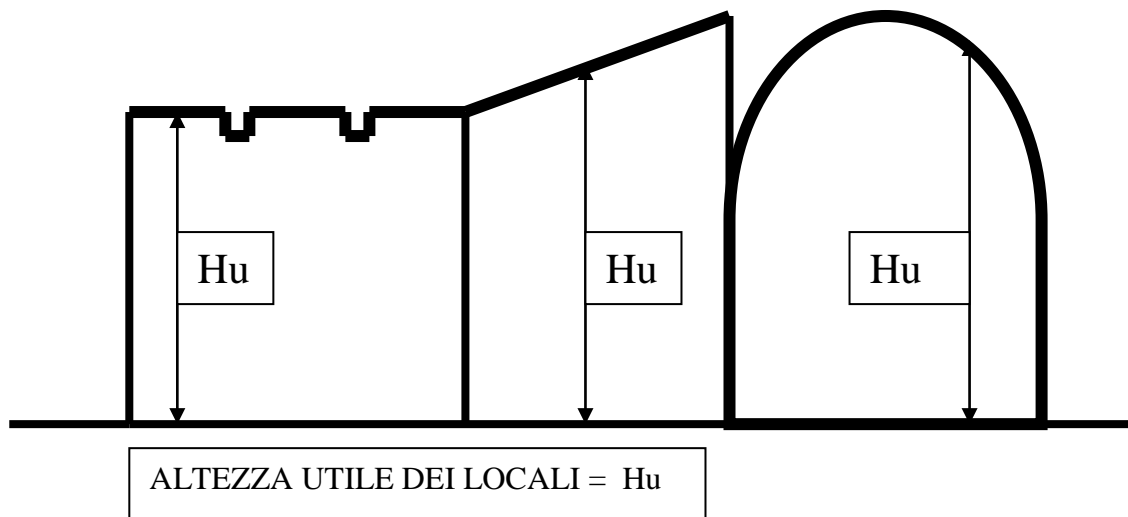
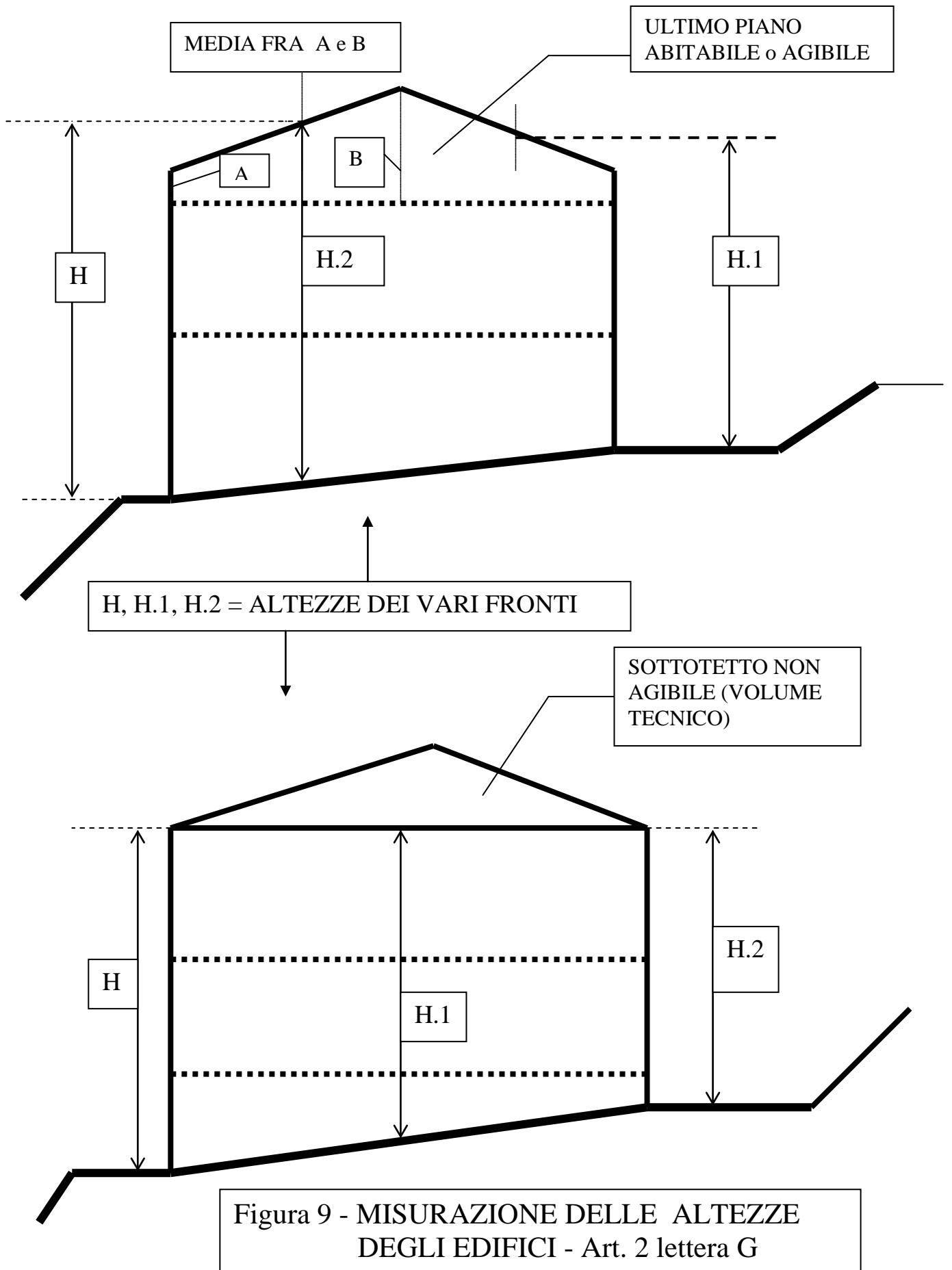
$$H_p = (A + B + C) / d$$

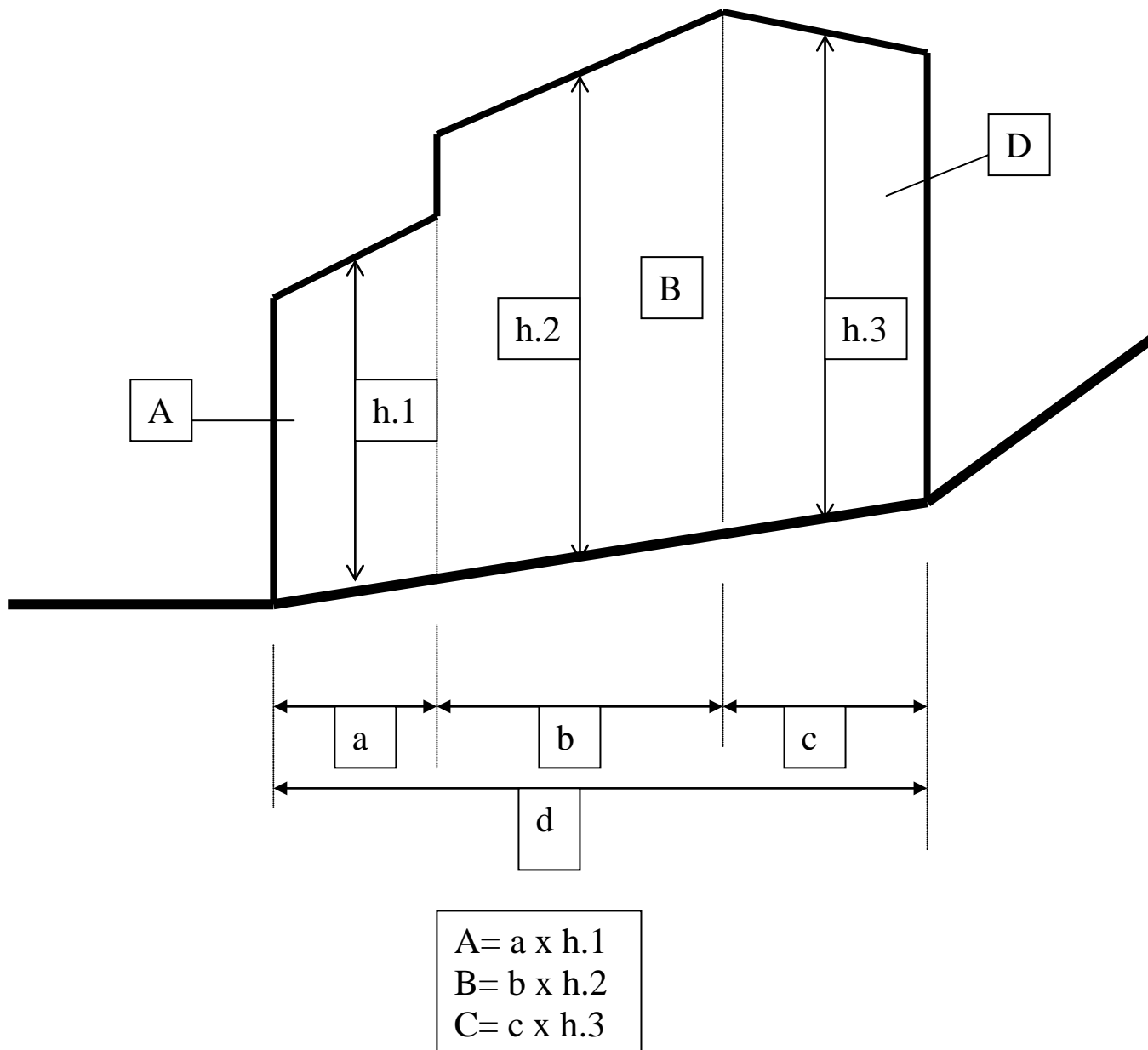
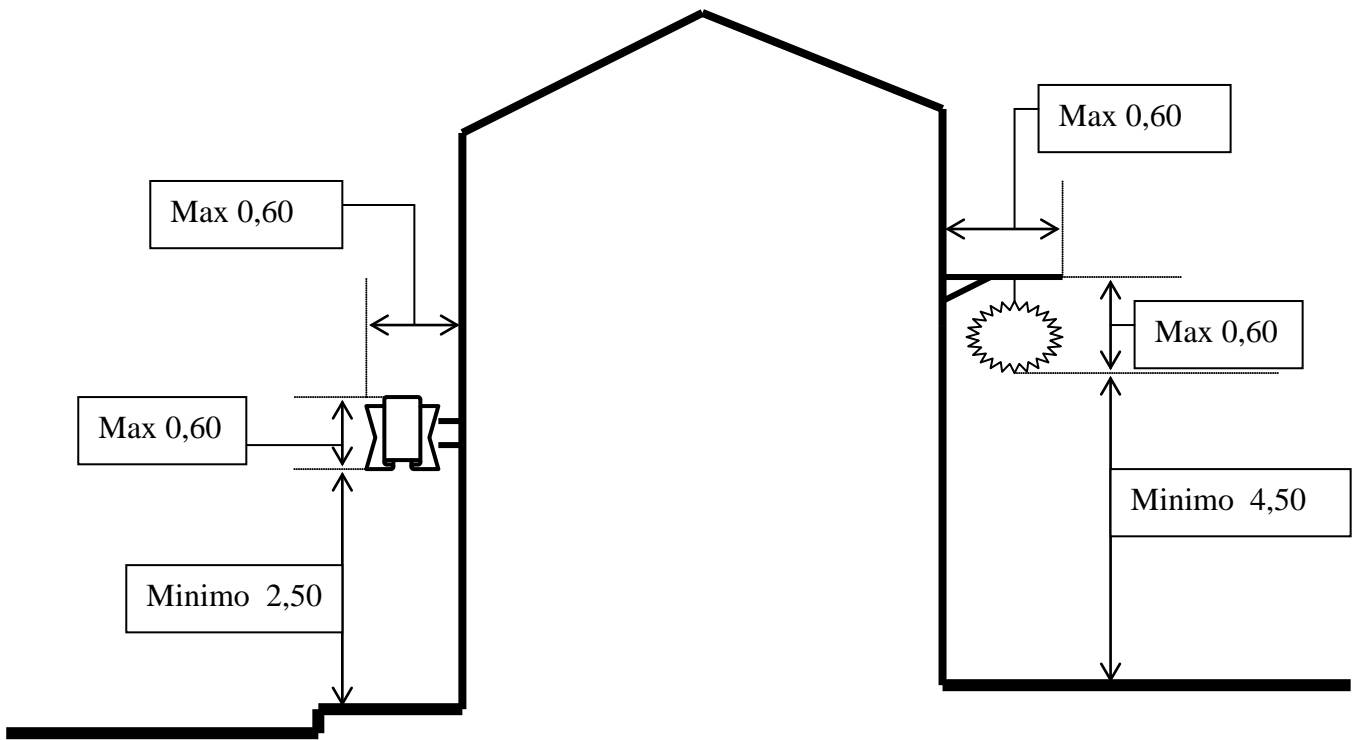

Figura 11 – INSEGNE A BANDIERA – Art. 60 punto 7

Arch. Filippo Fantoni

Con l'apporto collaborativo  
Degli Uffici Tecnici Comunali  
di Fiumalbo, Pievepelago, Riolunato

APRILE 2007